

## A-Series Miniature Explosion Proof Pressure Switches

Ashcroft® A-Series miniature explosion proof pressure switches are designed for tough applications where conventional pressure switch designs often don't measure up.

A rugged all 316 SS IP67 enclosure gives uncompromising protection over a wide temperature range for the most demanding hazardous area applications.

### FEATURES:

- Compact size
- 316 stainless steel construction
- Pressure ranges from vacuum to 7500 psi
- Field adjustable setpoint or factory set only
- Wide operating temperature range (-40° to 89°C) max.
- Hermetically sealed micro-switch
- Precision snap-acting micro switch element
- SPDT or DPDT switching
- CSA listed
- UL listed
- FM approved
- Atex & IECEx
- SIL 3 capable
- CRN
- Dual seal rated
- CE and ROHS compliant



SIL 3 CAPABLE



LOOK FOR THESE MARKS ON OUR PRODUCTS

Applications include:

## Oil and gas industry

- Offshore oil rigs
- Oil & Gas Production
- Oil Pipelines
- Gas Transmission/Distribution Systems
- Refineries (where 316 stainless steel construction and small size is desirable)

## Chemical and petrochemical plants

- Process Industries
- Process Gas
- Pumps, Compressors & Turbines (where small size and corrosion resistance construction is important)

## Other special machinery and equipment applications

- where small size and high performance are desirable

A rugged 316 SS enclosure gives uncompromising protection. Materials of construction have been selected for long life. Precision snap acting micro switches are featured and fully encased to prevent moisture from corroding switch contacts.

The switch, depending on range, is either an all welded 316 stainless steel diaphragm sealed piston design or a direct acting piston design sealed with a Buna-N or Viton O-ring.

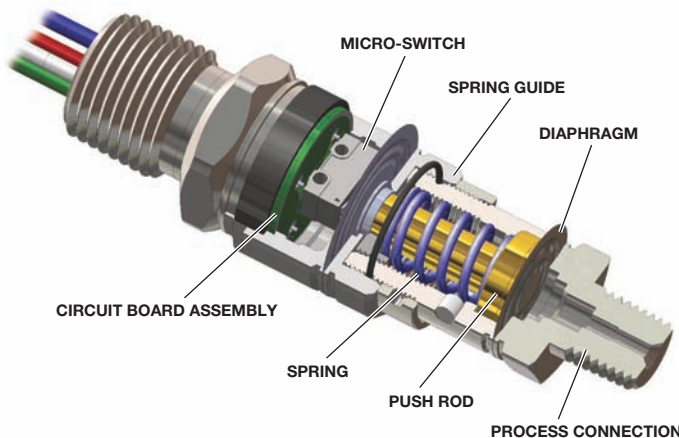

*Cutaway view of switch assembly with welded SS diaphragm*

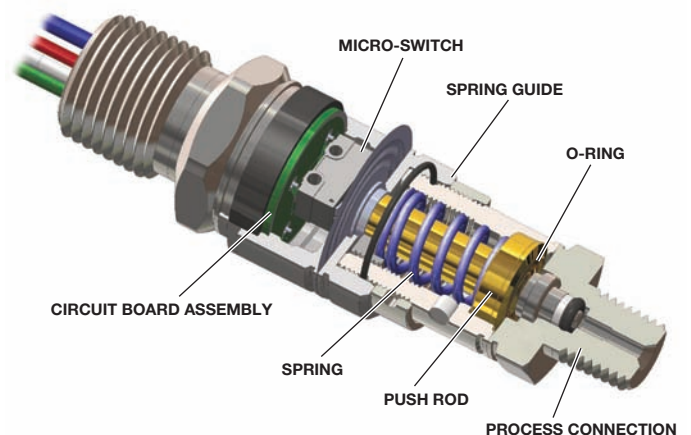

*Cutaway view of switch assembly with SS piston*



# A-Series Miniature Explosion Proof Pressure Switches

## SELECTION GUIDE

Before selecting a switch model the following should be considered:

### Actuator:

The actuator responds to changes in pressure and operates the micro switch element in response to these changes. The actuator is normally exposed to the process media and must be chemically compatible with it. There are three types of actuators available for the A-Series switches – all welded 316 SS diaphragm sealed piston; 316 SS piston with Viton O-ring seal; and 316 SS piston with Buna-N O-ring seal. The 316 SS diaphragm is available in ranges from -15/15 psi to 200 psi. The 316 SS piston is available in ranges from 100 psi to 7,500 psi. Switches offered in 100 psi and 200 psi can be ordered with either the piston or diaphragm design. The piston design will have a longer mechanical life, while the diaphragm design has a better operating temperature.

The piston design is more reliable than a diaphragm design when subjected to frequent large pressure excursions, pressure surges and spikes associated with typical hydraulic applications. Piston designs are typically used when the switch is used as low pressure alarm or cutoff where the normal working pressure is above the nominal range of the switch.

### The Switching Function:

Most applications for alarm, shutdown and interlock are satisfied by the standard A-Series switches which feature single setpoint fixed deadband. For pump, compressor and other control applications, the dead-band becomes a very important consideration and may require

increasing the range of the switch to increase the deadband. Please consult your Ashcroft representative for assistance with special applications.

### The Micro Switch Element:

The micro switch element must be chosen to meet the electrical load requirement to be switched. The switches are offered as either SPDT (single pole double throw) or DPDT (double pole double pole). The DPDT switch is made up of two SPDT switches which are adjusted to work together by Ashcroft's patent pending Circuit Board Rotation Design. DPDT switching is not available on diaphragm designs below 100 psi.

### Understanding Setpoints and Reset Points:

Pressure switches can be set to switch on either increasing (rising) or decreasing pressures. Since the switches have both Normally Open (NO) contacts and Normally Closed (NC) contacts you can wire the switch to have a switch open or closure for either an increasing or decreasing pressure. To be consistent in setting the switches Ashcroft defines the setpoints as follows. For an increasing setpoint, the pressure is increased from 0 psi to the set point and then decreased to the reset point. For a decreasing setpoint, the pressure is increased to full range and then decreased to the setpoint and then increased to the reset point.

### Custom Applications:

The A-series switch is designed to allow custom process connections. Please consult your Ashcroft representative for assistance with custom applications.



## AVAILABLE ELECTRICAL CONNECTIONS

1/2" NPT CONDUIT CONNECTOR WITH 18 AWG WIRE LEADS



## AVAILABLE PRESSURE CONNECTIONS

1/8 or 1/4" MALE NPT



1/8 or 1/4" FEMALE NPT



VCR or VCO



7/16"-20 SAE



3/4", 1.5" or 2.0" SANITARY





## SPECIFICATIONS:

- Setpoint:** Factory set or field adjustable
- Setpoint repeatability:** ±2% of range  
(Additional setpoint shift of ±2% of range per 40°F from initial setpoint set at 70°F typical)
- Vibration:** Passed MIL-STD-202G
- Shock:** 75G's 10 milliseconds 3 axis
- Piston:** Stainless steel with Viton or Buna-N O-ring
- Mechanical life piston design:** >1,000,000 operations typical
- Diaphragm:** 316L SS
- Mechanical life diaphragm design:** >400,000 operations typical
- Enclosure material:** 316L SS
- Enclosure rating:** NEMA 4X, 7, 9, IP 67
- Pressure connection:** 1/8" NPTF, 1/4" NPTF, 1/4" NPTM, 1/2" NPTM, 7/16"-20 SAE M, VCR, VCO, 3/4" Tri-Clamp®, 1.5" Tri-Clover®, 2.0" Tri-Clover®, G 3/4" B, G 1/2" A Type E Stub end
- Electrical output:** SPDT, or DPDT 5A or 3A 120Vac, 2A @ 30 Vdc, 5A @ 28 Vac, gold contacts available
- Electrical termination:** 18 AWG wire leads, with 1/2" NPT conduit connection.

## APPROVALS:



  
 CLASS I DIV 1 GROUPS A, B, C, & D  
 CLASS II DIV 1 GROUPS E, F, & G  
 T5 or T6 – see Material and Temperature Range Table

**Sira** 13ATEX1123X **IECEx** CSA 13.0015X  
 II 2GD  
 Ex d IIC T6/T5 Gb  
 Ex tb IIIC T85°C/100°C Db  
 T5 or T6 – see Material and Temperature Range Table

## Dual Seal

The A- series explosion proof pressure switch is designed to meet the requirements of ANSI/ISA-12.27.01-2003 for process sealing between electrical systems and flammable or combustible material.

Tri-Clover is a registered trademark of Alfa Laval  
 Tri-Clamp is a registered trademark of Ladish Co.



# A-Series Miniature Explosion Proof Pressure Switches

A SERIES SWITCH PERFORMANCE CHARACTERISTICS												
	RANGE			SETPOINT REPEATABILITY			SETPOINT ADJUSTABILITY			DEADBAND (DB)		
	psi	bar kg/cm <sup>2</sup>	kPa	psi	bar, kg/cm <sup>2</sup>	kPa	psi	bar, kg/cm <sup>2</sup>	kpa	psi	bar, kg/cm <sup>2</sup>	kPa
DIAPHRAGM	-15/15	-1/1	-100/100	±0.6	±.04	±4	-15/15	-1/1	-100/100	1-5	.07-.35	7-35
	30	2	200	±0.6	±.04	±4	6-30	0.4-2	4-200	1-5	.07-.35	7-35
	60	4	400	±1.2	±.08	±8	8-60	.6-4	60-400	2-10	.14-.70	14-70
	100	7	700	±2	±.14	±14	10-100	.7-7	70-700	3-15	.2-1.0	20-100
	200	14	1400	±4	±.28	±28	20-200	1.4-1.4	140-1400	3-30	.2-2.0	20-200
PISTON	100	7	700	±2	±.14	±14	20-100	1.4-7	140-700	3-15	.2-1.0	20-100
	200	14	1400	±4	±.28	±28	40-200	2.8-1.4	280-1400	3-30	.2-2.0	20-200
	500	35	3500	±10	±.70	±70	50-500	3.5-35	350-3500	20-100	1.4-7.0	140-700
	1000	70	7000	±20	±1.40	±140	100-1000	7-70	700-7000	25-150	1.7-10	170-1000
	2000	140	14000	±40	±2.8	±280	200-2000	14-140	1400-1400	30-300	2-20	200-2000
	5000	350	35000	±100	±7.0	±700	500-5000	35-350	3500-35000	75-750	5-50	500-5000
	7500	500	50000	±150	±10	±1000	750-7500	50-500	5000-50000	110-1100	7.5-75	750-7500

ELECTRIC	
Switch Code	Electric on Label
1P	3A 125Vac; 2A, 30Vdc
1H, 2H	5A 125/250Vac; 5A, 28Vdc
1G	0.1A 125Vac; 0.1A 30Vdc
1L, 2L	1A 125Vac; 1A 28Vdc

MATERIAL AND TEMPERATURE RATINGS (based on mat'l and switch code)							
Switch CODE	with MAT'L CODE	MATERIAL	TEMP. MIN	T5 Ta MAX	T5 Tp MAX	T6 Ta MAX	T6 Tp MAX
1H, 2H, 1L, 2L	S	316 ST.SL.	-40°C	89°C	89°C	74°C	74°C
1H, 2H, 1L, 2L	B (Ranges: 100#, 200#)	316 SS, BUNA	-28°C	89°C	89°C	74°C	74°C
1H, 2H, 1L, 2L	B (Ranges 500 and UP)	316 SS, BUNA	-40°C	89°C	89°C	74°C	74°C
1H, 2H, 1L, 2L	V	316 SS, VITON	-20°C	89°C	89°C	74°C	74°C
1P, 1G	S	316 SS	-20°C	74°C	74°C	74°C	74°C
1P, 1G	B (Ranges: 100#, 200#)	316 SS, BUNA	-20°C	74°C	74°C	74°C	74°C
1P, 1G	B (Ranges 500 and UP)	316 SS, BUNA	-20°C	74°C	74°C	74°C	74°C
1P, 1G	V	316 SS, VITON	-20°C	74°C	74°C	74°C	74°C

BURST PRESSURE				"MWP" and "PROOF" PRESSURES								
Ranges (Material) listed in psi	psi	Bar, kg/cm <sup>2</sup>	kPa	CONFIGURATION		MAX. WORKING PRESSURE "MWP"				PROOF PRESSURE "PROOF"		
				RANGES (psi)	w/SEAL	psi	bar, kg/cm <sup>2</sup>	kPa	MPa	psi	bar kg/cm <sup>2</sup>	kPa
Up to 200 (S)	>9500	>655	>65,500	up to 200	S	800	55	5500	5.5	1000	70	7000
100-200 (B,V)	>10,000	>700	>70,000	100-200	B or V	2000	140	1400	14	2500	170	17000
500-2000 (B,V)	>30,000	>2100	>210,000	500-2000	B or V	5000	350	35000	35	8000	550	55000
5000-7500 (B,V)	>50,000	>3500	>350,000	5000-7500	B or V	10000	700	70000	70	15000	1000	100000

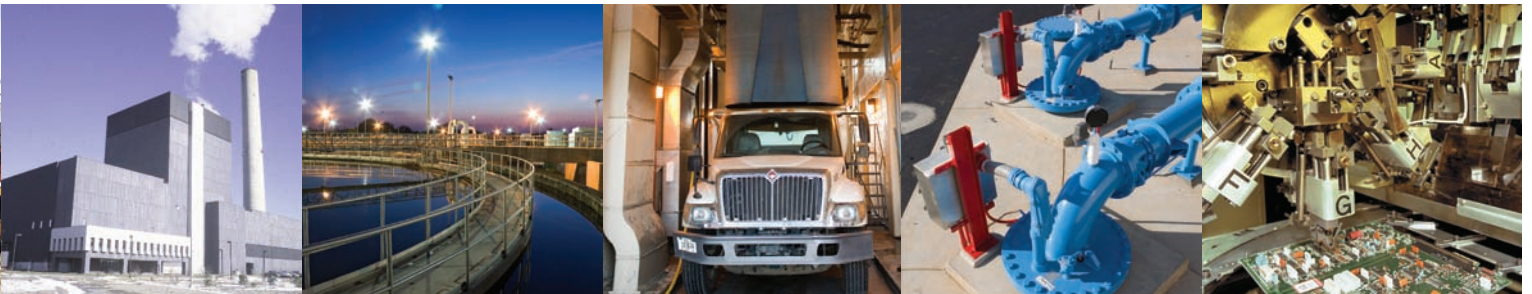

1 – FUNCTION	
<b>APS</b> – Pressure switch, single setpoint, fixed dead-band, factory set, not field adjustable <b>APA</b> – Pressure switch, single setpoint, fixed dead-band, field adjustable	
2 – ENCLOSURE (BODY)	
<b>N7</b> – Explosion Proof 316 SS body	
3 – MICRO SWITCH, FIRST CHARACTER	
Code	
<b>1</b>	Single Switch – SPDT
<b>2</b>	Dual Switch – DPDT (not available with “S” actuator or P&G micro switch)
3 – MICRO SWITCH, SECOND CHARACTER	
Code	
<b>G</b>	Gold Contact – 0.1 A @ 125 Vac, 0.1 A @ 30 Vdc
<b>H</b>	Higher Current – 5A @ 125/250 Vac, 5A @ 28 Vdc resistive, 3A @ 28 Vdc inductive
<b>L</b>	Higher Current Gold Contacts – 1A @125 Vac, 1A @ 28 Vdc resistive, 0.5A @ 28 Vdc Inductive
<b>P</b>	General Purpose – 3A @ 125 Vac, 2A @30 Vdc
4 – ELECTRICAL CONNECTION	
Code	
<b>012C‡</b>	½ NPT male conduit connection with 18 AWG wires 12” length
5 – ACTUATOR SEAL	
Code	
<b>B</b>	316 SS piston & Buna O-ring, ranges ≥100 psi
<b>V</b>	316 SS piston & Viton O-ring, ranges ≥100 psi
<b>S</b>	316 SS welded Diaphragm, ranges ≤200 psi

‡ First three digits represent the length of the wire leads in inches. 012, 024, 048 & 072 are standard available lengths. Consult factory for custom length availability.

6 – PRESSURE CONNECTION	
Code	Description
<b>01</b>	¼ NPT Male
<b>02</b>	¼ NPT Male
<b>03</b>	¼ NPT Female*
<b>25</b>	¼ NPT Female*
<b>05</b>	7/16-20 SAE Male
<b>06</b>	VCR Fixed*
<b>07</b>	VCO Fixed*
<b>12</b>	G ¼ A (Type E stud end)
<b>13</b>	G ¼ B
<b>75</b>	0.75” Tri-Clamp® connection (includes 3A Approval) with glycerin fill†
<b>15</b>	1.5” Tri-Clover® connection (includes 3A Approval) with glycerine fill†
<b>20</b>	2.0” Tri-Clover® connection (includes 3A Approval) with glycerine fill†

7 – PRESSURE RANGE				
Actuator	psi	Bar	kPa	Kg/cm²
S	-15/15#	-1/1BR	-100/100KP	-1/1KSC
S	30#	2BR	200KP	2KSC
S	60#	4BR	400KP	4KSC
B, S, V	100#	7BR	700KP	7KSC
B, S, V	200#	14BR	1400KP	14KSC
B, V	500#	35BR	3500KP	35KSC
B, V	1000#	70BR	7000KP	70KSC
B, V	2000#	140BR	14000KP	140KSC
B, V	5000#	350BR	35000KP	350KSC
B, V	7500#	500BR	50000KP	500KSC

8 – SETPOINT	
5 characters maximum representing setpoint of the switch in the same units as the range of the switch. For setpoints in Vacuum specify as “-” pressure.	

9 – SETPOINT DIRECTION	
Code	Description
<b>R</b>	Rising Pressure (Increasing Pressure, Decreasing Vacuum)
<b>D</b>	Decreasing Pressure, Increasing Vacuum

10 – OPTIONS	
Code	Description
<b>XC4</b>	Individual certified calibration chart
<b>XFP</b>	Fungus proofing
<b>XMQ</b>	Positive Material Identification (75, 15 & 20 process conn. only)
<b>XNC</b>	2 wire leads + ground wire – wired for normally closed operation
<b>XNO</b>	2 wire leads + ground wire – wired for normally open operation
<b>XNH</b>	Stainless Steel Tag
<b>XNN</b>	Paper Tag
<b>X6B</b>	Cleaned for Oxygen service
<b>XGO</b>	Ground Wire Omitted
<b>XUV</b>	Unvented, not dual seal rated (APA version only)

### HOW TO ORDER:

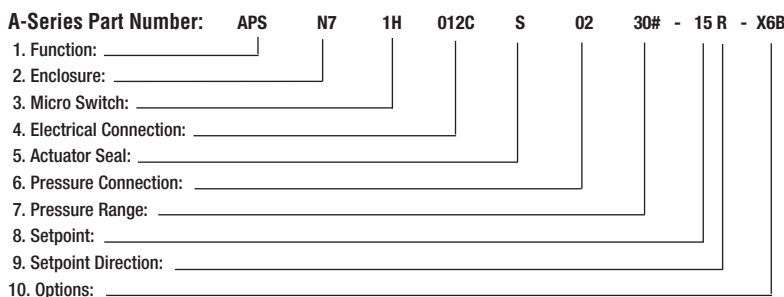

### PRESSURE CONNECTION NOTES

\* Available with “S” activator only.

† Ranges ≤ 500 psi.

### SETPOINT NOTES

If no setpoint is required on an APA switch use either “NSR” or “NSD”. If direction is not known use “NSR” as the default.

### OPTIONS NOTES

The X character will only appear before the first option, additional options will just be the two characters. Example: XC4NC6B

If the switch is mounted to a diaphragm seal other than (75, 15, 20 connection) the seal fill fluid is also listed as an X option.

# A-Series Miniature Explosion Proof Pressure Switches

## ADDITIONAL SWITCH TERMINOLOGY

**Accuracy** – (See repeatability) Accuracy normally refers to conformity of an indicated value to an accepted standard value. There is no indication in switch products; thus, instead, the term repeatability is used as the key performance measure. Ashcroft A-Series switch accuracy is 2% of nominal range.

**Automatic Reset Switch** – Switch which returns to normal state when actuating variable Pressure is reduced.

**Adjustable or Operating Range** – That part of the nominal range over which the switch setpoint may be adjusted. Normally about 10% to 100% of the nominal range for A-Series pressure switches.

**Burst Pressure** – The maximum pressure that may be applied to a pressure switch without causing leakage or rupture. This is approximately 16X of nominal range for A-Series switches. Diaphragm switches subjected to pressures above the nominal range can be permanently damaged.

**Deadband** – The difference between the setpoint and the resetpoint, normally expressed in units of the actuating variable. Sometimes referred to as differential.

**Fixed Deadband** – The difference between the setpoint and the resetpoint of a pressure switch. It further signifies that this deadband is a fixed function of the pressure switch and not adjustable.

**National Electrical Manufacturers Association (NEMA)** – This group has defined several categories of enclosures, usually referred to as “types.” Further, they designate certain features and capabilities each type must include.

**NEMA 6** – Enclosures constructed for either indoor or outdoor use to provide a degree of protection to personnel against access to hazardous parts; to provide a degree of protection of the equipment inside the enclosure against ingress of solid foreign objects (falling dirt); to provide a degree of protection with respect to harmful effects on the equipment due to the ingress of water (hose directed water and the entry of water during occasional temporary submersion at a limited depth); and that will be undamaged by the external formation of ice on the enclosure.

**Normal Switch Position** – Contact position before actuating pressure (or variable) is applied.

Normally closed contacts open when the switch is actuated. Normally open contacts close when the switch is actuated.

**Normally Closed** – Refers to switch contacts that are closed in the normal switch state or position (unactuated). A pressure change opens the contacts.

**Normally Open Switch** – Refers to the contacts that are open in the normal switch state or position (unactuated). A pressure change closes the contacts.

**Overpressure Rating(s)** – A nonspecific term that could refer to either burst or proof pressure, or both.

**Proof Pressure** – The maximum pressure which may be applied without causing damage. This is determined under strict laboratory conditions including controlled rate of change and temperature: This value is for reference only. Consult factory for applications where switch must operate at pressures above nominal range or reference temperature (70°F).

**Repeatability (Accuracy)** – The closeness of agreement among a number of consecutive measurements of the output setpoint for the same value of the input under the same operating conditions, approaching from the same direction, for full-range traverses. Ashcroft A-series switch repeatability is 2% of nominal range.

**Note:** It is usually measured as non-repeatability and expressed as repeatability in percent of span or nominal range. It does not include hysteresis or deadband.

**Resetpoint** – The resetpoint is the Pressure value where the electrical switch contacts will return to their original or normal position after the switch has activated.

**Setpoint** – The setpoint is the Pressure value at which the electrical circuit of a switch will change state or actuate. It should be specified either on increase or decrease of that variable.

**Single Pole Double Throw (SPDT) Switching Element** – A SPDT switching element has one

normally open, one normally closed, and one common terminal. The switch can be wired with the circuit either normally open (N/O) or normally closed (N/C). SPDT is standard with A-series switches.

**Double Pole Double Throw (DPDT) Switching Element** – Two SPDT switching elements both set

to actuate or de-actuate at the same set or resetpoint. Each switch one has one normally open, one normally closed, and one common terminal. The switches are independent of each other and can be wired to two independent circuits. The two circuits can either normally open (N/O) or normally closed (N/C).

**Snap Action** – In switch terminology, snap action generally refers to the action of contacts in the switch element. These contacts open and close quickly and snap closed with sufficient pressure to firmly establish an electrical circuit. The term distinguishes products from mercury bottle types that were subject to vibration problems.



FUNCTION CODE			
Description	Dim. A		
APS (Factory Set)	1.06		
APA (Field Adjustable)	1.64		
MICRO SWITCH			
Description	Dim. B		
1H, 2H, 1L, 2L	1.07		
1P, 2P, 1G, 2G	.94		
PRESSURE CONNECTION GENERAL DIMENSION			
Code	Description	Dim. C	Dim. D
01	1/8 NPT Male	0.45	0.41
02	1/4 NPT Male	0.56	0.54
03	1/8 NPT Female	0.75	0.65
04	1/4 NPT Female	0.92	0.75
05	7/16-20SAE	0.56	0.44
06	VCR Fixed Male	0.58	0.56
07	VCO Fixed Male	0.47	0.56
12	G $\frac{3}{4}$ Form A		
13	G $\frac{3}{4}$ Form B		
15	1.5" Tri-Clamp Seal	1.23	1.99
20	2.0" Tri-Clamp Seal	1.23	2.49
75	3/4" Fractional Seal	1.10	0.96



Sira 13ATEX1123X IECEx  
CSA 13.0015X  
LOOK FOR THESE MARKS ON OUR PRODUCTS



SIL 3 CAPABLE

## DIMENSIONS:

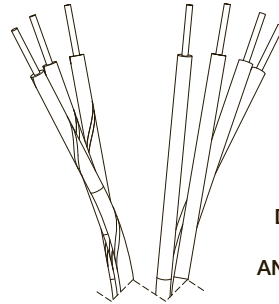

DUAL SWITCH SHOWN  
WITH APA HOUSING  
AND 1/4 NPT PRESSURE  
CONNECTION

